

**RO** INSTRUCTIUNI DE ASAMBLARE - **DULAP MALMO 3 USI - 1200 x 520 x 2000 MM**

**EN** ASSEMBLY INSTRUCTIONS - **WARDROBE 3 DOORS - 1200 x 520 x 2000 MM**

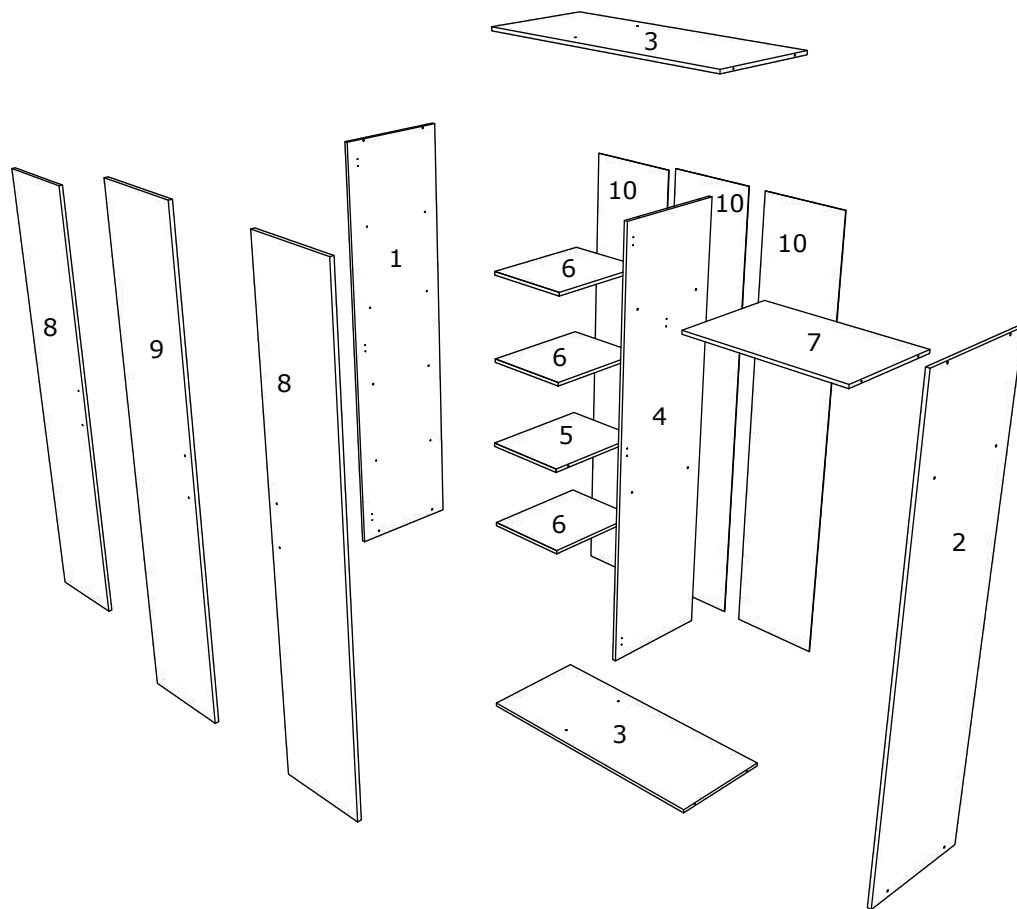

**RO**

NUMAR	LUNGIME	LATIME	BUC	CULOARE
1	2000	520	1	CULOARE1
2	2000	520	1	CULOARE1
3	1168	500	2	CULOARE1
4	1948	500	1	CULOARE1
5	382	500	1	CULOARE1
6	382	492	3	CULOARE1
7	770	500	1	CULOARE1
8	1980	386	2	CULOARE2
9	1980	386	1	CULOARE2
10	1976	398	3	PFL SPATE

**EN**

NUMBER	LENGHT	WIDTH	PCS	COLOUR
1	2000	520	1	COLOUR1
2	2000	520	1	COLOUR1
3	1168	500	2	COLOUR1
4	1948	500	1	COLOUR1
5	382	500	1	COLOUR1
6	382	492	3	COLOUR1
7	770	500	1	COLOUR1
8	1980	386	2	COLOUR2
9	1980	386	1	COLOUR2
10	1976	398	3	BACK PANNEL

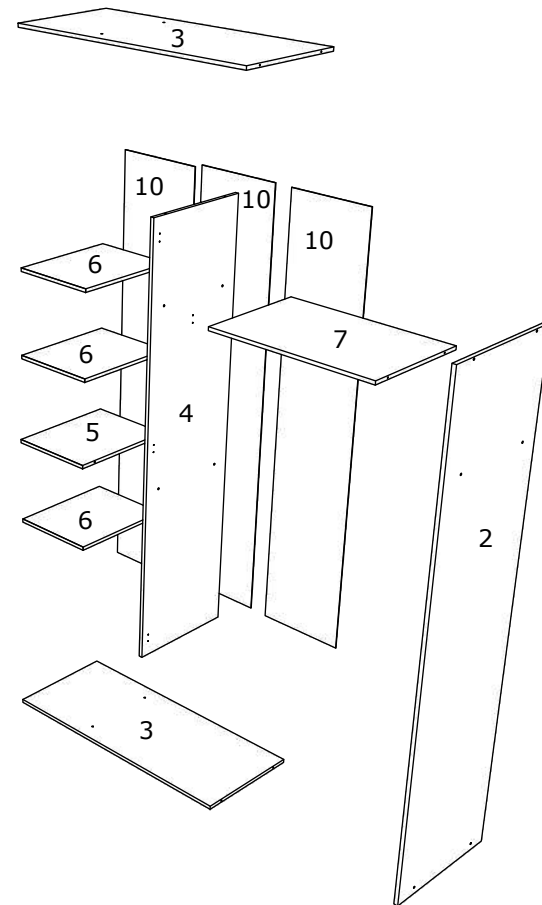
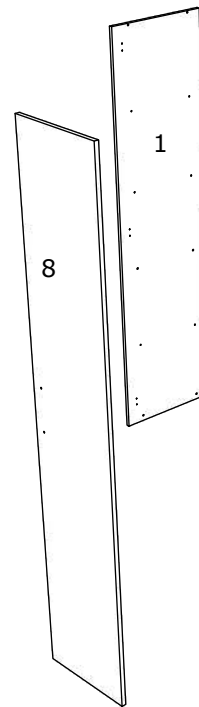
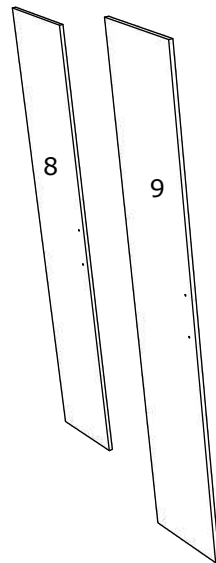
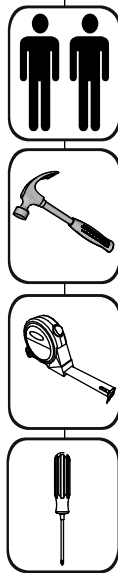
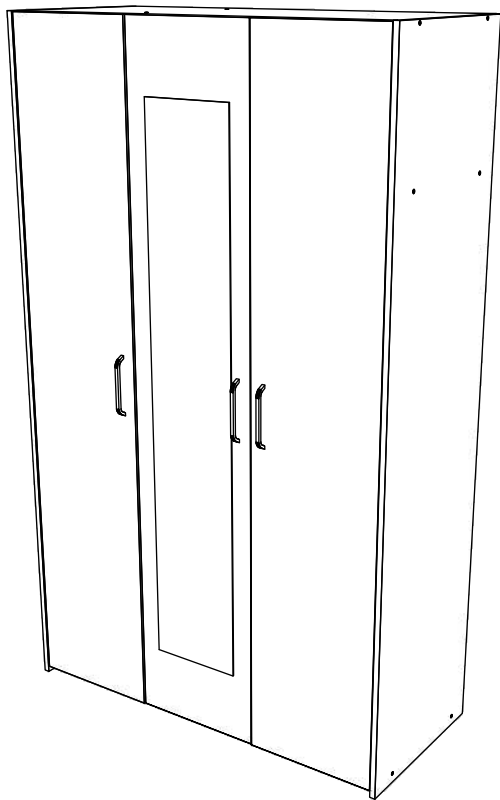

A	7x50mm	B		C		D	L = 764 mm	E		F	
	20x		16x		104x		1x		6x		3x
G		H		I		J	L = 1564 mm L = 360 mm	K		L	3.5 x 16 mm
	2x		12x		4x		2x		1x		x 40
M	3.5 x 25 mm	N	160 mm	O	M4 x 20mm	P					
	x 8		x 3		x 6		x 4				

EN

NUMBER	LENGHT	WIDTH	PCS	COLOUR
1	2000	520	1	COLOUR1
2	2000	520	1	COLOUR1
3	1168	500	2	COLOUR1
4	1948	500	1	COLOUR1
5	382	500	1	COLOUR1
6	382	492	3	COLOUR1
7	770	500	1	COLOUR1
8	1980	386	2	COLOUR2
9	1980	386	1	COLOUR2
10	1976	398	3	BACK PANNEL



## RO **INSTRUCTIUNI DE SIGURANTA ! MOBILIER**

Pentru a preveni accidente nedorite, este important ca mobilierul să fie montat corespunzător, iar corpurile înalte ( peste 70cm ) să fie fixate de perete. De asemenea, rafturile și sertarele nu trebuie să fie supraîncărcate, iar mobilierul trebuie verificat periodic pentru a identifica eventuale semne de uzură sau instabilitate. A se evita deschiderea tuturor sertarelor simultan pentru corpurile cu sertare multiple. Respectarea acestor reguli contribuie nu doar la un mediu mai sigur, dar și la prelungirea duratei de viață a pieselor de mobilier. Dacă mobilierul cade, pot apărea leziuni grave sau fatale. Utilizați accesorii de fixare potrivite pentru pereții locuinței dvs. Vă rugăm să urmați cu atenție fiecare pas al instrucțiunilor. Dacă aveți întrebări cu privire la dispozitivele de fixare, contactați comerciantul.

### **Corpuri superioare:**

Este necesar să fixați mobilierul de perete pentru a preveni răsturnarea accidentală, mai ales în cazul rafturilor și dulapurilor suspendate. Asigurați-vă că mobilierul este bine asamblat și nu prezintă semne de instabilitate. Evitați supraîncărcarea corpurilor superioare, pentru a preveni riscul de cădere a acestora. Utilizați scări sau scaune stabile pentru a ajunge la rafturile superioare, evitând sprijinirea pe mobilierul în sine. Examinați materialul peretelui pentru a verifica dacă capacitatea de susținere este suficientă pentru greutatea preconizată. Folosiți șuruburi și dibluri potrivite pentru pereții casei dumneavoastră.

### **Mobilier pentru copii:**

Toate piesele de mobilier destinate copiilor, care solicită această operațiune, trebuie fixate corespunzător pe perete, pentru a preveni răsturnarea accidentală. Este important ca mobilierul să fie utilizat sub supraveghere constantă, mai ales în cazul copiilor mici, care pot deveni curioși și își pot pune în pericol siguranța. Evitați să atașați cârlige sau mânere suplimentare la toate corpurile de mobilier, în care copiii s-ar putea accidenta. Pentru a preveni căderea mobilierului, acesta trebuie fixat de perete cu dispozitive adecvate. Examinați materialul peretelui pentru a verifica dacă capacitatea de susținere este suficientă pentru greutatea preconizată. Folosiți șuruburi și dibluri potrivite pentru pereții casei dumneavoastră.

## EN **SAFETY INSTRUCTIONS ! FURNITURE**

To prevent unwanted accidents, it is important that furniture is properly assembled and tall cabinets (over 70cm) are secured to the wall. Shelves and drawers should also not be overloaded and furniture should be checked regularly for signs of wear or instability. Avoid opening all drawers at once for cabinets with multiple drawers. Following these rules not only contributes to a safer environment, but also to extending the life of the furniture. If furniture falls, serious or fatal injuries can occur. Use fixing accessories suitable for the walls of your home. Please follow each step of the instructions carefully. If you have any questions about the fixing devices, contact your dealer.

### **Upper cabinets:**

It is necessary to secure furniture to the wall to prevent accidental tipping, especially in the case of shelves and wall cabinets. Make sure that the furniture is well assembled and does not show signs of instability. Avoid overloading upper cabinets to prevent the risk of them falling. Use ladders or stable chairs to reach the upper shelves, avoiding leaning on the furniture itself. Examine the wall material to check that the bearing capacity is sufficient for the expected weight. Use screws and dowels suitable for the walls of your home.

### **Children's furniture:**

All pieces of furniture intended for children, which require this operation, must be properly fixed to the wall to prevent accidental tipping. It is important that the furniture is used under constant supervision, especially in the case of small children, who can become curious and endanger their safety. Avoid attaching additional hooks or handles to all furniture, where children could injure themselves. To prevent furniture from falling, it must be fixed to the wall with appropriate devices. Examine the wall material to check that the bearing capacity is sufficient for the expected weight. Use screws and dowels suitable for the walls of your home.

## DE SICHERHEITSHINWEISE ! MÖBEL

Um unerwünschte Unfälle zu vermeiden, ist es wichtig, dass Möbel richtig zusammgebaut und hohe Schränke (über 70 cm) an der Wand befestigt werden. Regale und Schubladen sollten ebenfalls nicht überladen werden und Möbel sollten regelmäßig auf Anzeichen von Verschleiß oder Instabilität überprüft werden. Vermeiden Sie es, bei Schränken mit mehreren Schubladen alle Schubladen auf einmal zu öffnen. Das Befolgen dieser Regeln trägt nicht nur zu einer sichereren Umgebung bei, sondern verlängert auch die Lebensdauer der Möbel. Wenn Möbel herunterfallen, können schwere oder tödliche Verletzungen auftreten. Verwenden Sie Befestigungszubehör, das für die Wände Ihres Hauses geeignet ist. Bitte befolgen Sie jeden Schritt der Anleitung sorgfältig. Wenn Sie Fragen zu den Befestigungsvorrichtungen haben, wenden Sie sich an Ihren Händler.

### **Oberschränke:**

Es ist notwendig, Möbel an der Wand zu befestigen, um ein versehentliches Umkippen zu verhindern, insbesondere bei Regalen und Wandschränken. Stellen Sie sicher, dass die Möbel gut zusammgebaut sind und keine Anzeichen von Instabilität aufweisen. Vermeiden Sie eine Überlastung der Oberschränke, um das Risiko eines Herunterfallens zu vermeiden. Verwenden Sie Leitern oder stabile Stühle, um die oberen Regale zu erreichen, und vermeiden Sie es, sich auf die Möbel selbst zu stützen. Untersuchen Sie das Wandmaterial, um sicherzustellen, dass die Tragfähigkeit für das erwartete Gewicht ausreicht. Verwenden Sie Schrauben und Dübel, die für die Wände Ihres Hauses geeignet sind.

### **Kindermöbel:**

Alle für Kinder bestimmten Möbelstücke, bei denen dieser Vorgang erforderlich ist, müssen ordnungsgemäß an der Wand befestigt werden, um ein versehentliches Umkippen zu verhindern. Es ist wichtig, dass die Möbel unter ständiger Aufsicht verwendet werden, insbesondere bei kleinen Kindern, die neugierig werden und ihre Sicherheit gefährden können. Vermeiden Sie das Anbringen zusätzlicher Haken oder Griffe an allen Möbeln, an denen sich Kinder verletzen könnten. Um ein Herunterfallen der Möbel zu verhindern, müssen diese mit geeigneten Vorrichtungen an der Wand befestigt werden. Untersuchen Sie das Wandmaterial, um sicherzustellen, dass die Tragfähigkeit für das erwartete Gewicht ausreicht. Verwenden Sie Schrauben und Dübel, die für die Wände Ihres Hauses geeignet sind.

## FR CONSIGNES DE SÉCURITÉ ! MEUBLES

Pour éviter les accidents indésirables, il est important que les meubles soient correctement assemblés et que les armoires hautes (plus de 70 cm) soient fixées au mur. Les étagères et les tiroirs ne doivent pas non plus être surchargés et les meubles doivent être vérifiés régulièrement pour détecter tout signe d'usure ou d'instabilité. Évitez d'ouvrir tous les tiroirs à la fois pour les armoires à plusieurs tiroirs. Le respect de ces règles contribue non seulement à un environnement plus sûr, mais également à prolonger la durée de vie des meubles. Si des meubles tombent, des blessures graves ou mortelles peuvent survenir. Utilisez des accessoires de fixation adaptés aux murs de votre maison. Veuillez suivre attentivement chaque étape des instructions. Si vous avez des questions sur les dispositifs de fixation, contactez votre revendeur.

### **Armoires supérieures :**

Il est nécessaire de fixer les meubles au mur pour éviter tout basculement accidentel, en particulier dans le cas des étagères et des armoires murales. Assurez-vous que les meubles sont bien assemblés et ne présentent aucun signe d'instabilité. Évitez de surcharger les armoires supérieures pour éviter tout risque de chute. Utilisez des échelles ou des chaises stables pour atteindre les étagères supérieures, en évitant de vous appuyer sur les meubles eux-mêmes. Examinez le matériau du mur pour vérifier que la capacité portante est suffisante pour le poids prévu. Utilisez des vis et des chevilles adaptées aux murs de votre maison.

### **Meubles pour enfants :**

Tous les meubles destinés aux enfants, qui nécessitent cette opération, doivent être correctement fixés au mur pour éviter tout basculement accidentel. Il est important que les meubles soient utilisés sous surveillance constante, en particulier dans le cas de petits enfants, qui peuvent devenir curieux et mettre en danger leur sécurité. Évitez de fixer des crochets ou des poignées supplémentaires à tous les meubles, où les enfants pourraient se blesser. Pour éviter que les meubles ne tombent, ils doivent être fixés au mur avec des dispositifs appropriés. Examinez le matériau du mur pour vérifier que la capacité portante est suffisante pour le poids prévu. Utilisez des vis et des chevilles adaptées aux murs de votre maison.

## **HU** BIZTONSÁGI UTASÍTÁSOK! BÚTOROK

A nem kívánt balesetek elkerülése érdekében fontos, hogy a bútorokat megfelelően összeszereljék, és a magas (70 cm feletti) szekrényeket a falhoz rögzítsék. A polcokat és a fiókokat sem szabad túlterhelni, és a bútorokat rendszeresen ellenőrizni kell, hogy nincsenek-e rajta kopás vagy instabilitás jelei. Kerülje az összes fiók egyidejű kinyitását több fiókkal rendelkező szekrények esetén. E szabályok betartása nemcsak a biztonságosabb környezet megteremtéséhez, hanem a bútorok élettartamának meghosszabbításához is hozzájárul. Ha a bútor leesik, súlyos vagy halálos sérüléseket okozhat. Használjon otthona falához megfelelő rögzítő kiegészítőket. Kérjük, gondosan kövesse az utasítások minden lépését. Ha kérdése van a rögzítőeszközökkel kapcsolatban, forduljon a forgalmazóhoz.

### **Felső szekrények:**

A bútorokat a falhoz kell rögzíteni, hogy elkerüljük a véletlen felborulást, különösen a polcok és fali szekrények esetében. Győződjön meg arról, hogy a bútorok jól vannak összeszerelve, és nem mutatják az instabilitás jeleit. Kerülje a felső szekrények túlterhelését, nehogy leessen. Használjon létrákat vagy stabil székeket a felső polcok eléréséhez, elkerülve, hogy magának a bútornak dőljön. Vizsgálja meg a fal anyagát, és ellenőrizze, hogy a teherbírás elegendő-e a várható súlyhoz. Használjon otthona falához megfelelő csavarokat és tipliket.

### **Gyermek bútorok:**

Minden olyan gyermekbútort, amely ezt a műveletet igényli, megfelelően rögzíteni kell a falhoz, hogy elkerülje a véletlen felborulást. Fontos, hogy a bútorokat állandó felügyelet mellett használjuk, különösen kisgyermekek esetében, akik kíváncsivá válhatnak és veszélyeztethetik a biztonságukat. Kerülje a további horgok vagy fogantyúk rögzítését minden bútorra, ahol a gyerekek megsérülhetnek. A bútorok leesésének elkerülése érdekében megfelelő eszközökkel a falhoz kell rögzíteni. Vizsgálja meg a fal anyagát, és ellenőrizze, hogy a teherbírás elegendő-e a várható súlyhoz. Használjon otthona falához megfelelő csavarokat és tipliket.

## **IT** ISTRUZIONI DI SICUREZZA ! MOBILI

Per prevenire incidenti indesiderati, è importante che i mobili siano montati correttamente e che i mobili alti (oltre 70 cm) siano fissati alla parete. I ripiani e i cassetti non devono essere sovraccarichi e i mobili devono essere controllati regolarmente per verificare che non vi siano segni di usura o instabilità. Evitare di aprire tutti i cassetti contemporaneamente per i mobili con più cassetti. Seguire queste regole non solo contribuisce a creare un ambiente più sicuro, ma anche a prolungare la durata dei mobili. Se i mobili cadono, possono verificarsi lesioni gravi o mortali. Utilizzare accessori di fissaggio adatti alle pareti della casa. Seguire attentamente ogni passaggio delle istruzioni. In caso di domande sui dispositivi di fissaggio, contattare il rivenditore.

### **Mobili superiori:**

È necessario fissare i mobili alla parete per evitare ribaltamenti accidentali, soprattutto nel caso di ripiani e mobili da muro. Assicurarsi che i mobili siano ben montati e non presentino segni di instabilità. Evitare di sovraccaricare i mobili superiori per evitare il rischio che cadano. Utilizzare scale o sedie stabili per raggiungere i ripiani superiori, evitando di appoggiarsi a loro stessi. Esaminare il materiale della parete per verificare che la capacità portante sia sufficiente per il peso previsto. Utilizzare viti e tasselli adatti alle pareti della propria casa.

### **Arredamento per bambini:**

Tutti i mobili destinati ai bambini, che richiedono questa operazione, devono essere fissati correttamente alla parete per evitare ribaltamenti accidentali. È importante che i mobili vengano utilizzati sotto costante supervisione, soprattutto nel caso di bambini piccoli, che possono diventare curiosi e mettere a repentaglio la loro sicurezza. Evitare di attaccare ganci o maniglie aggiuntivi a tutti i mobili, dove i bambini potrebbero farsi male. Per evitare che i mobili cadano, devono essere fissati alla parete con dispositivi appropriati. Esaminare il materiale della parete per verificare che la capacità portante sia sufficiente per il peso previsto. Utilizzare viti e tasselli adatti alle pareti della propria casa.

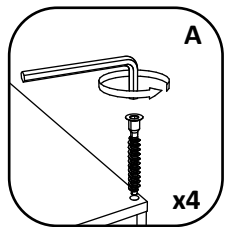
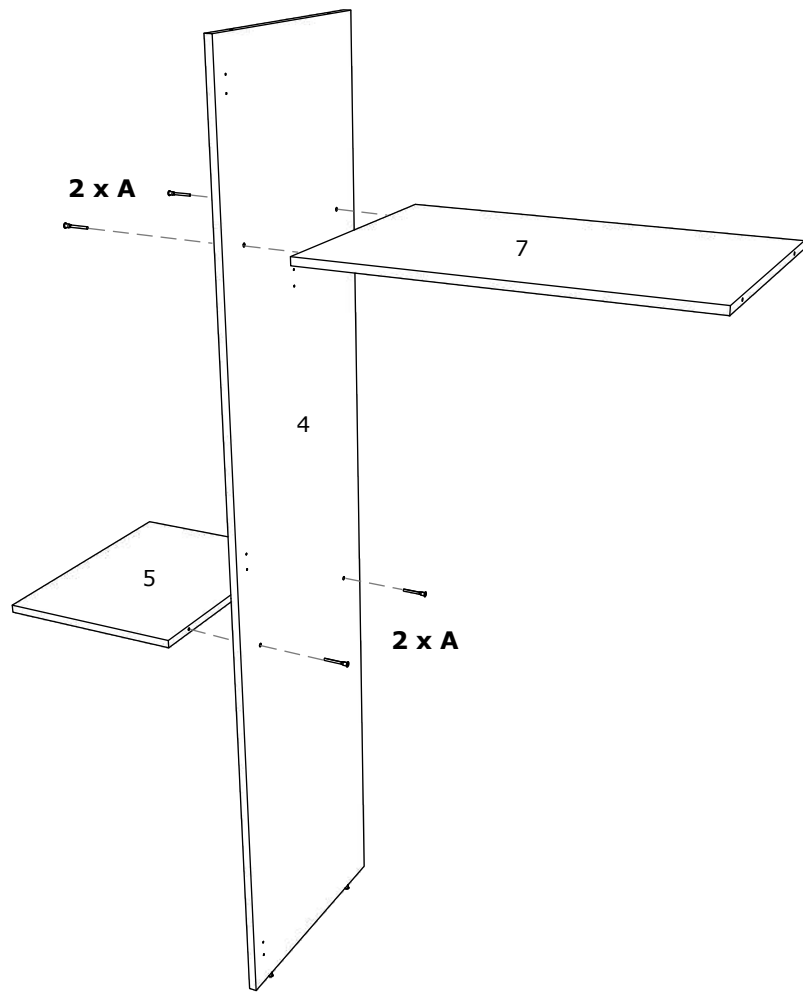

1

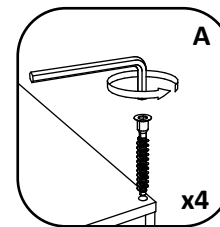
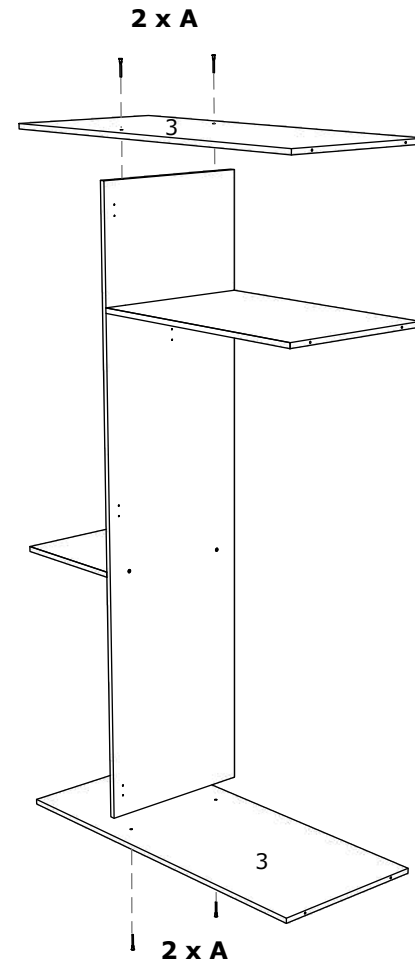

2

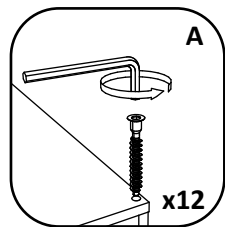
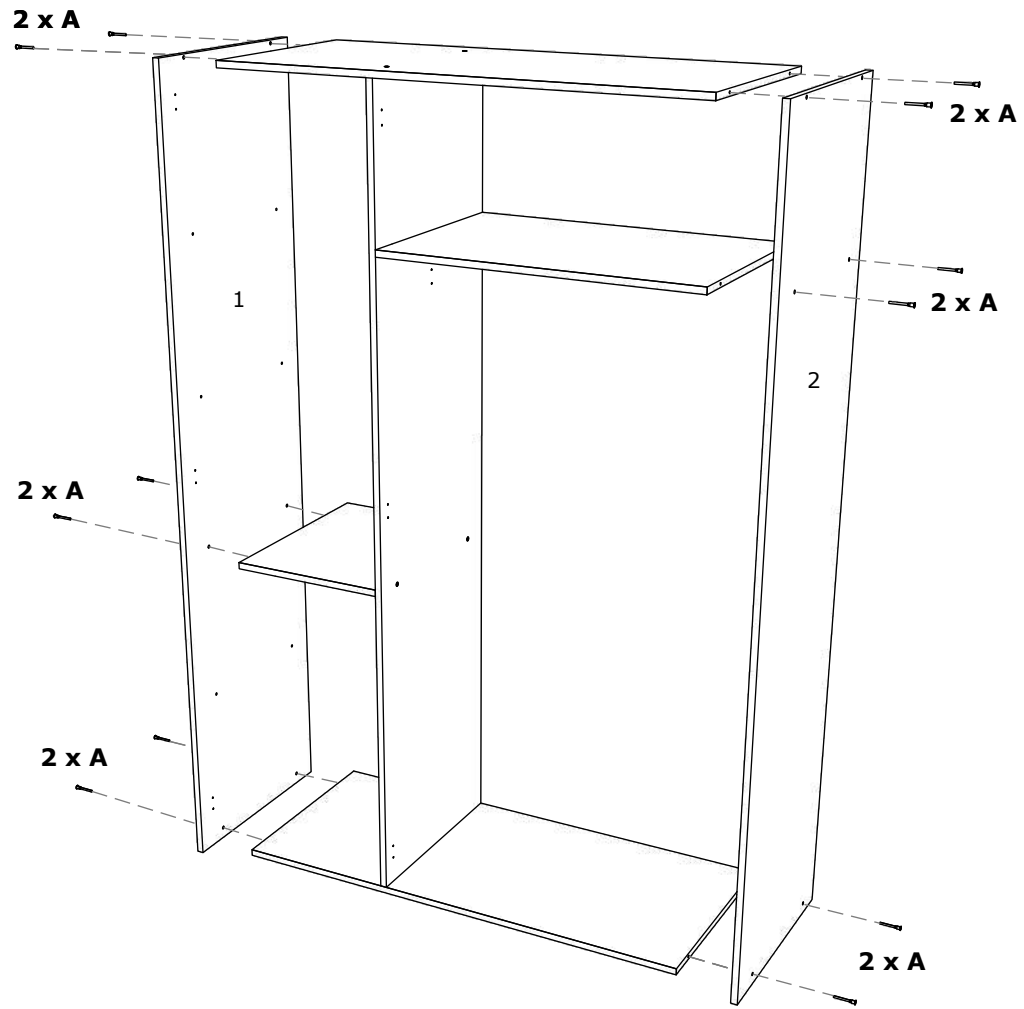

3

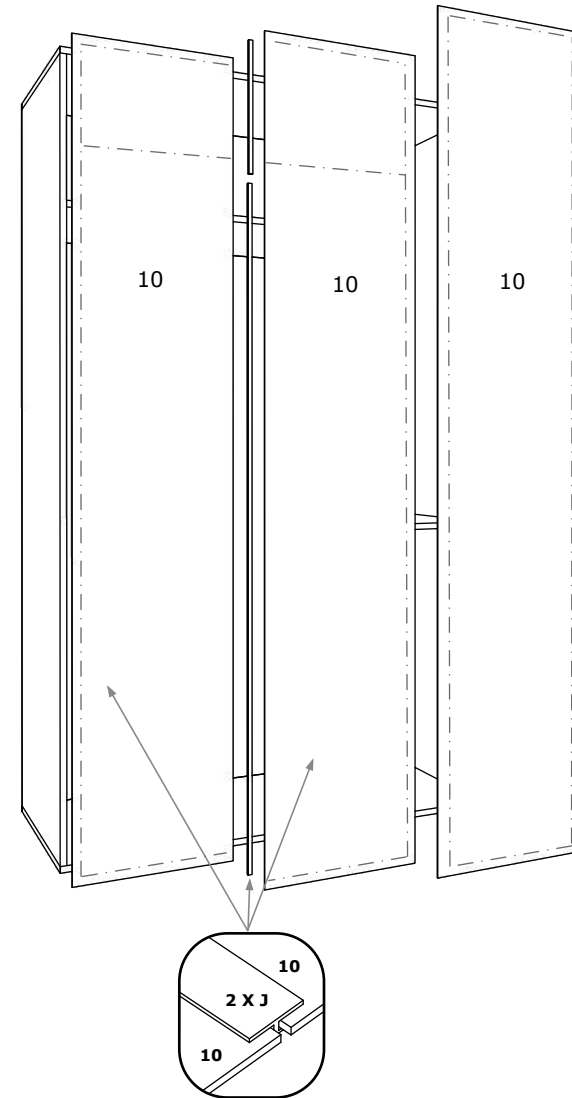
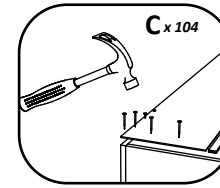

4

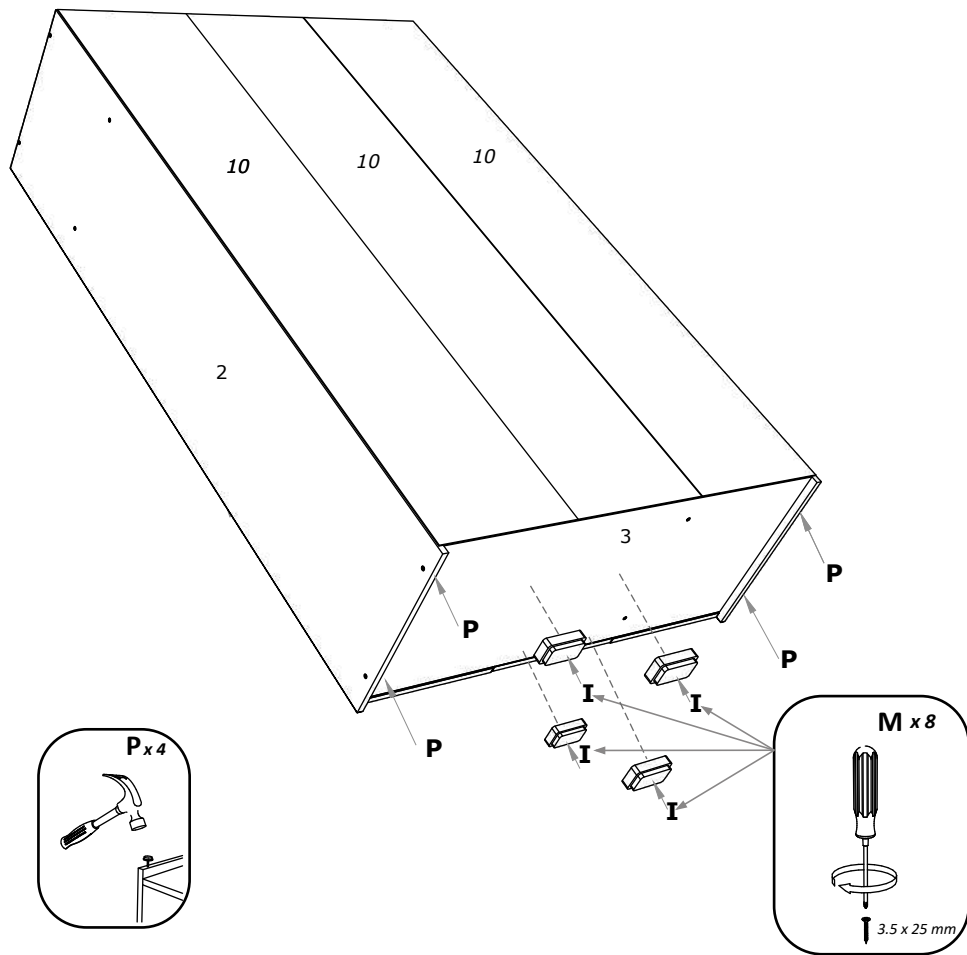

5

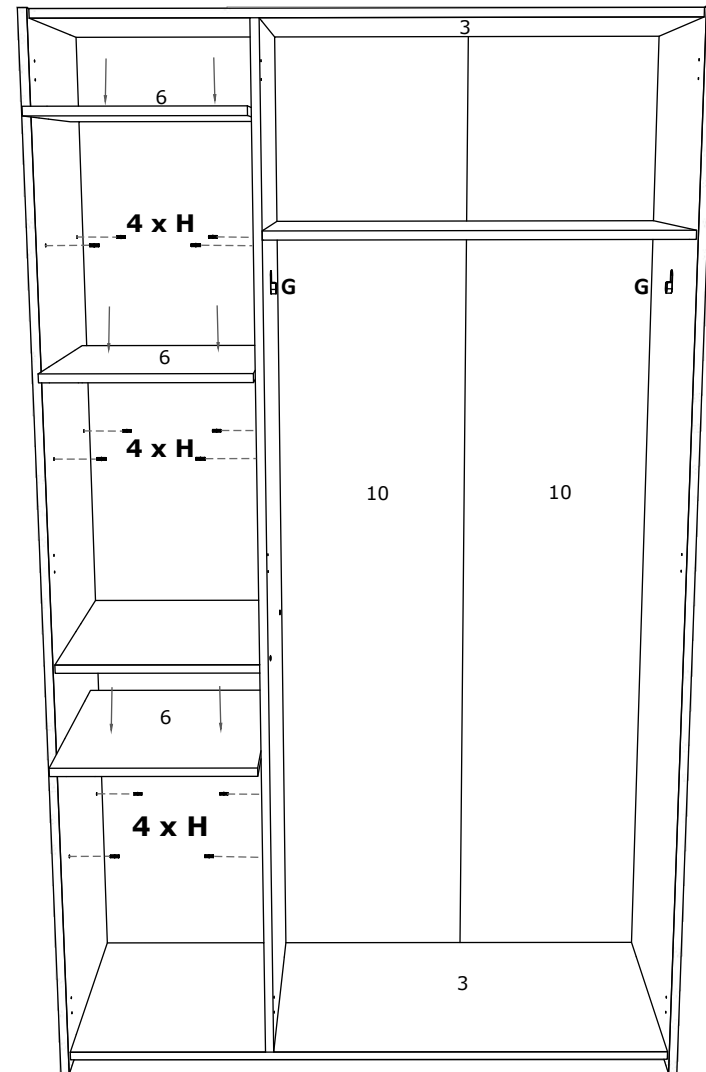

6



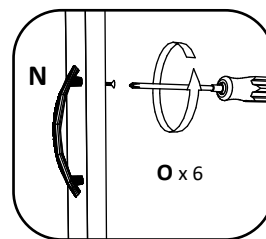
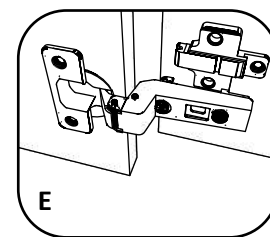
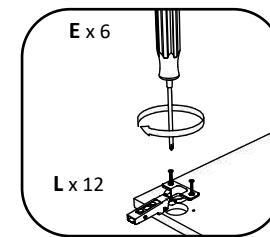
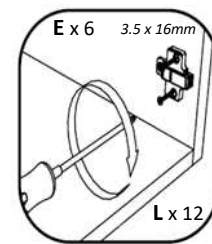
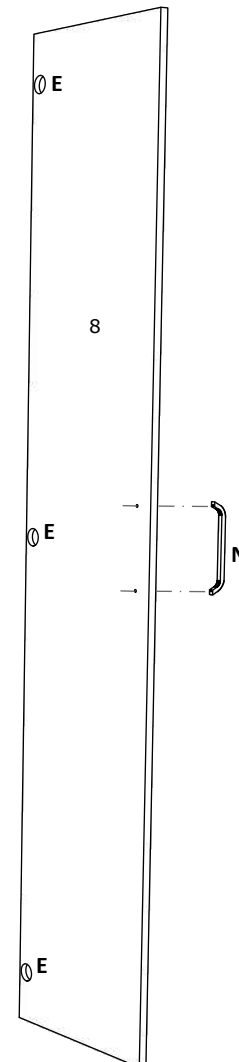
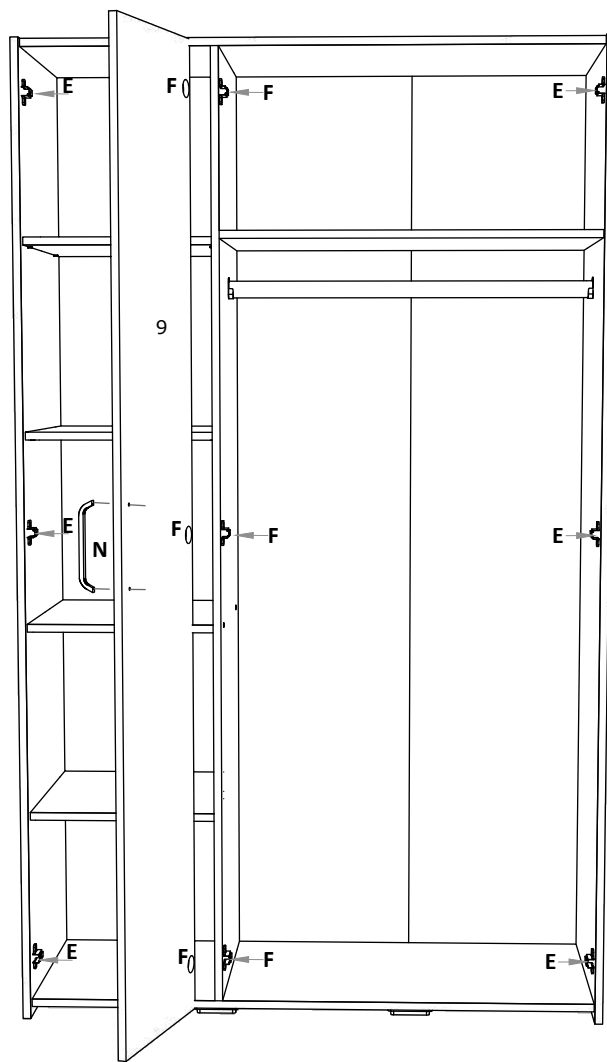
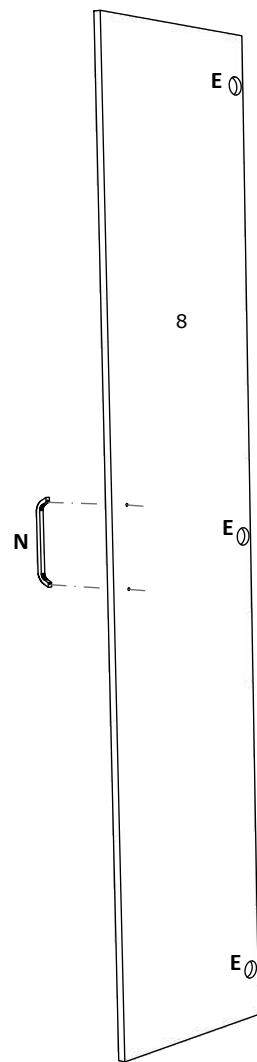
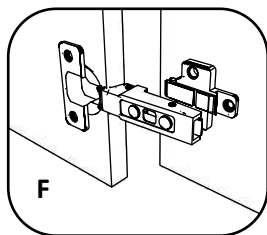
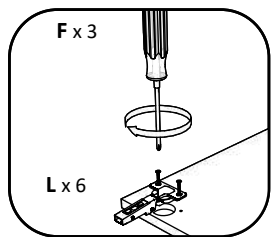
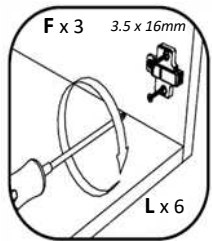

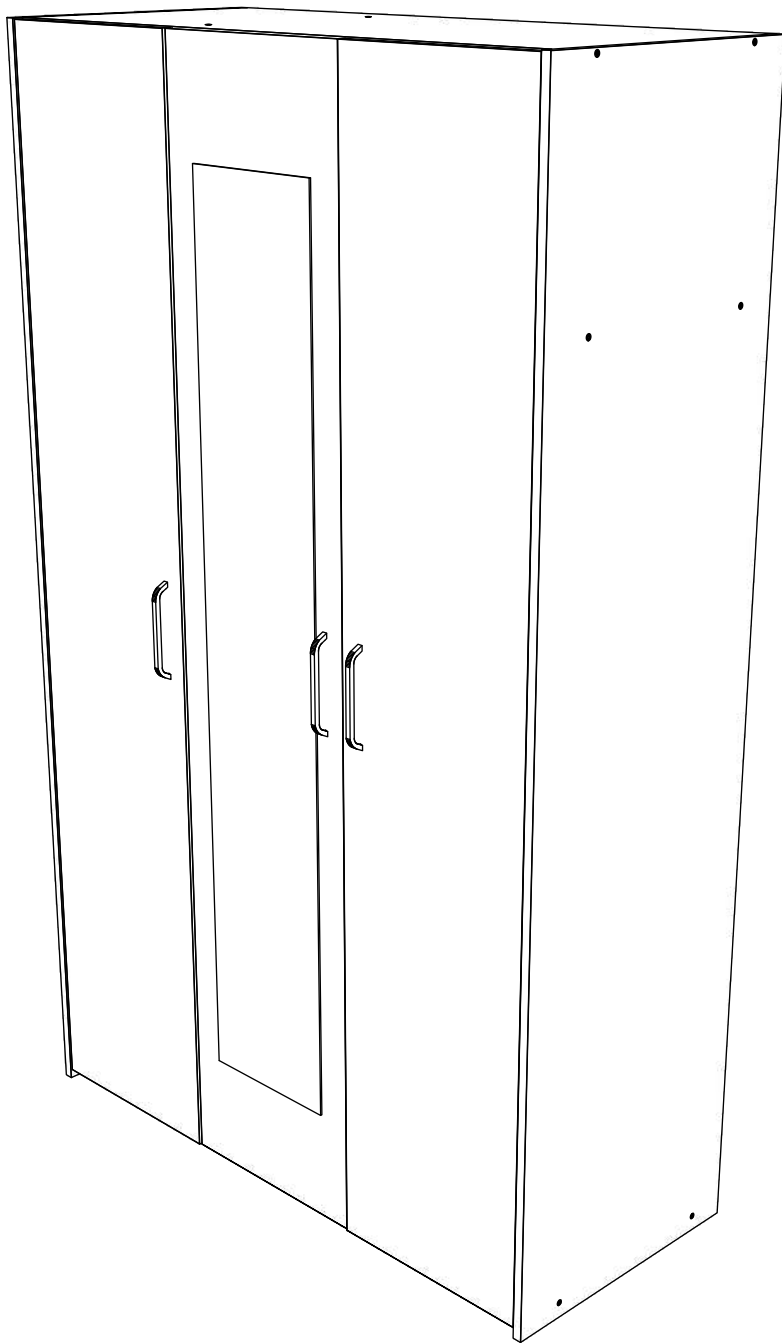

**RO** INSTRUCTIUNI DE ASAMBLARE - **DULAP MALMO 2 USI** - 810 x 520 x 2000 MM

**EN** ASSEMBLY INSTRUCTIONS - **MALMO WARDROBE 2 DOORS** - 810 x 520 x 2000 MM

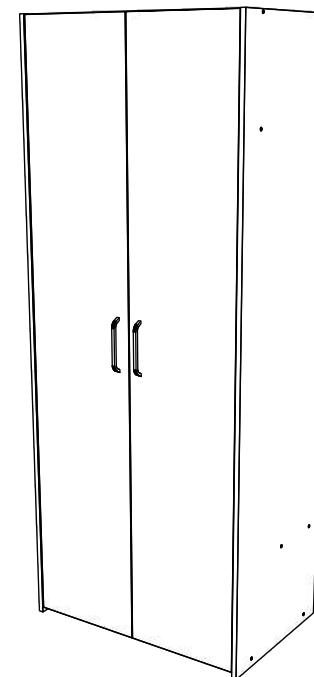
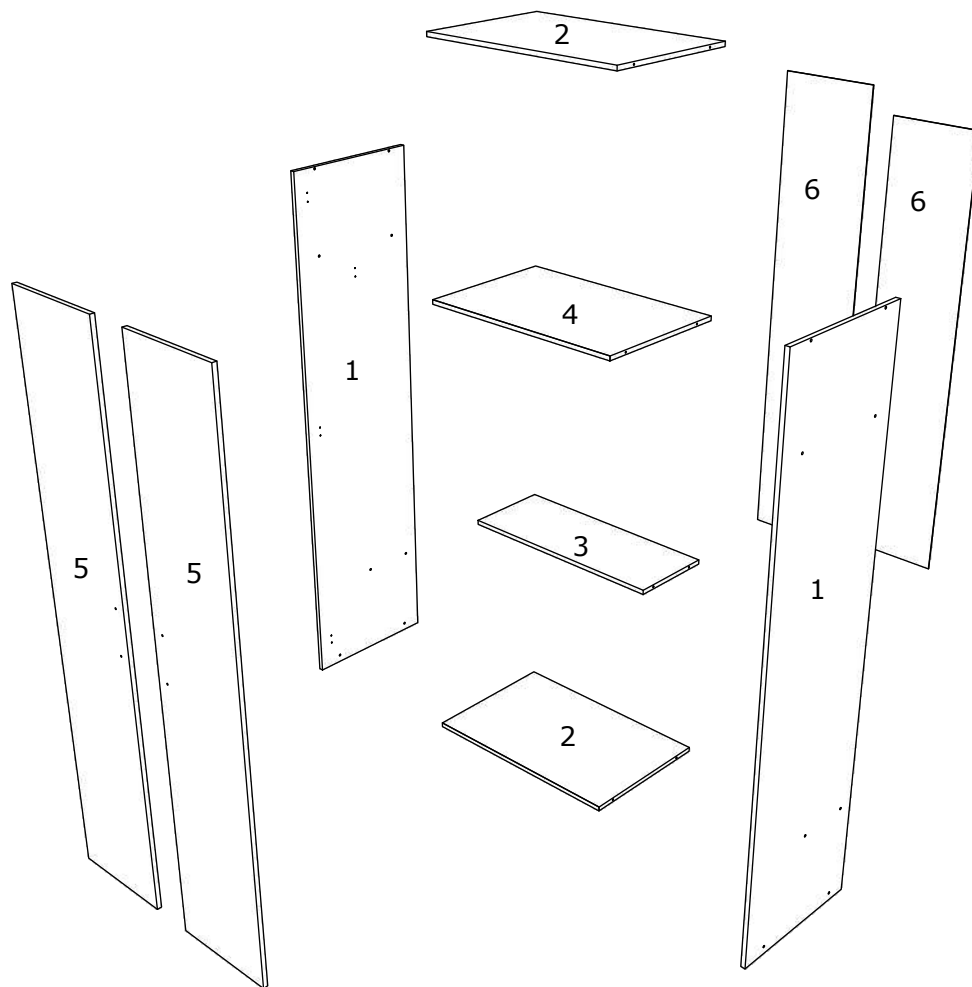









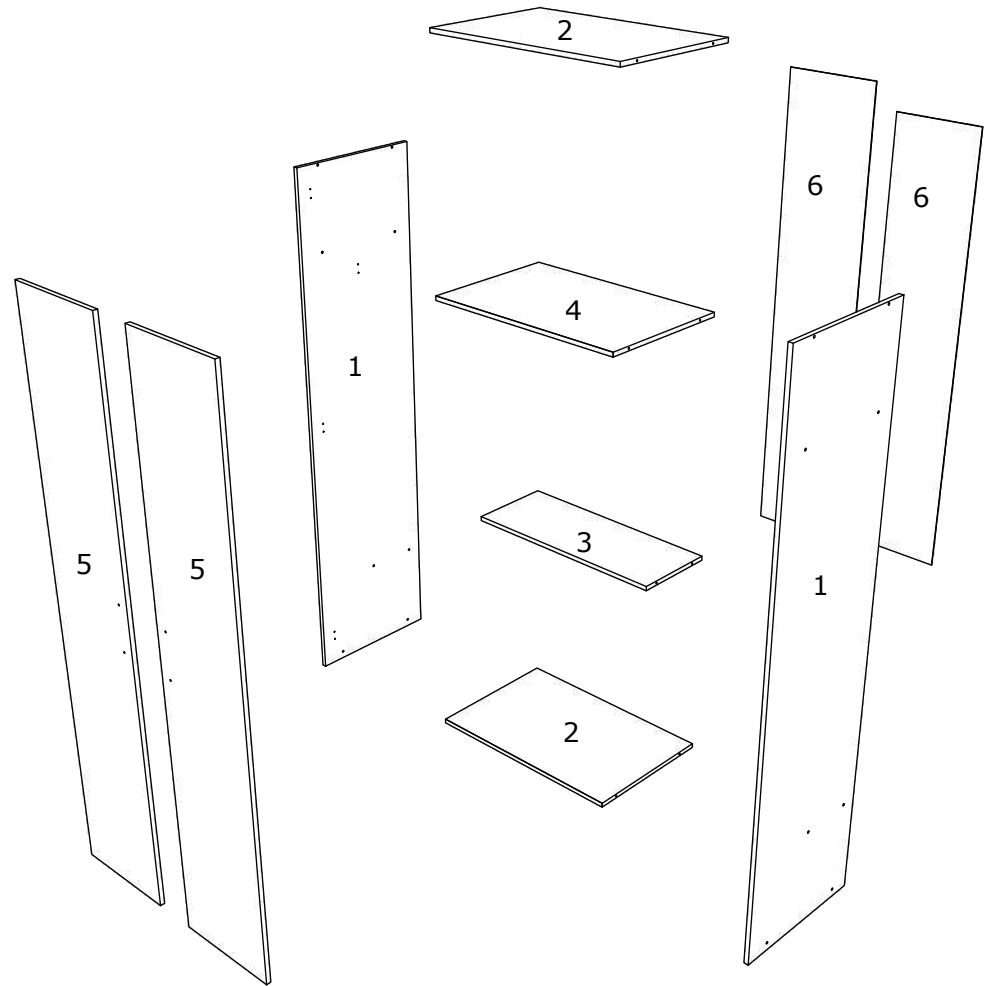

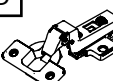

**RO**

NUMAR	LUNGIME	LATIME	BUC	CULOARE
1	2000	520	2	CULOARE1
2	778	500	2	CULOARE1
3	778	300	1	CULOARE1
4	778	500	1	CULOARE1
5	1980	386	2	CULOARE2
6	1976	401	2	PANOU SPATE

**EN**

NUMBE	RLENGTH	WIDTH	PCS	COLOUR
1	2000	500	2	COLOUR1
2	778	500	2	COLOUR1
3	778	300	1	COLOUR1
4	778	500	1	COLOUR1
5	1980	386	2	COLOUR2
6	1976	401	2	BACK PANNEL

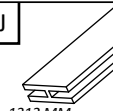
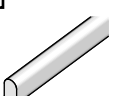
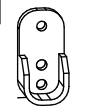

<b>A</b> 7x50mm  x 16	<b>B</b>  x 16	<b>C</b> 160 mm  x 2	<b>D</b>  x 6	<b>E</b> 3.5 x 16 mm  x 28
<b>F</b>  x 4	<b>G</b>  x 56	<b>H</b>  x 1	<b>I</b> M4 x 20mm  x 4	<b>J</b>  L=1312 MM L=296 MM L=396 MM x 3
<b>K</b> L=772 MM  x 1	<b>L</b>  x 2	<b>M</b>  x 2	<b>N</b> 3.5 x 25 mm  x 4	

EN

NUMBE	RELENGTH	WIDTH	PCS	COLOUR
1	2000	500	2	COLOUR1
2	778	500	2	COLOUR1
3	778	300	1	COLOUR1
4	778	500	1	COLOUR1
5	1980	386	2	COLOUR2
6	1976	401	2	BACK PANNEL

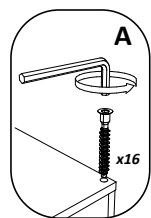
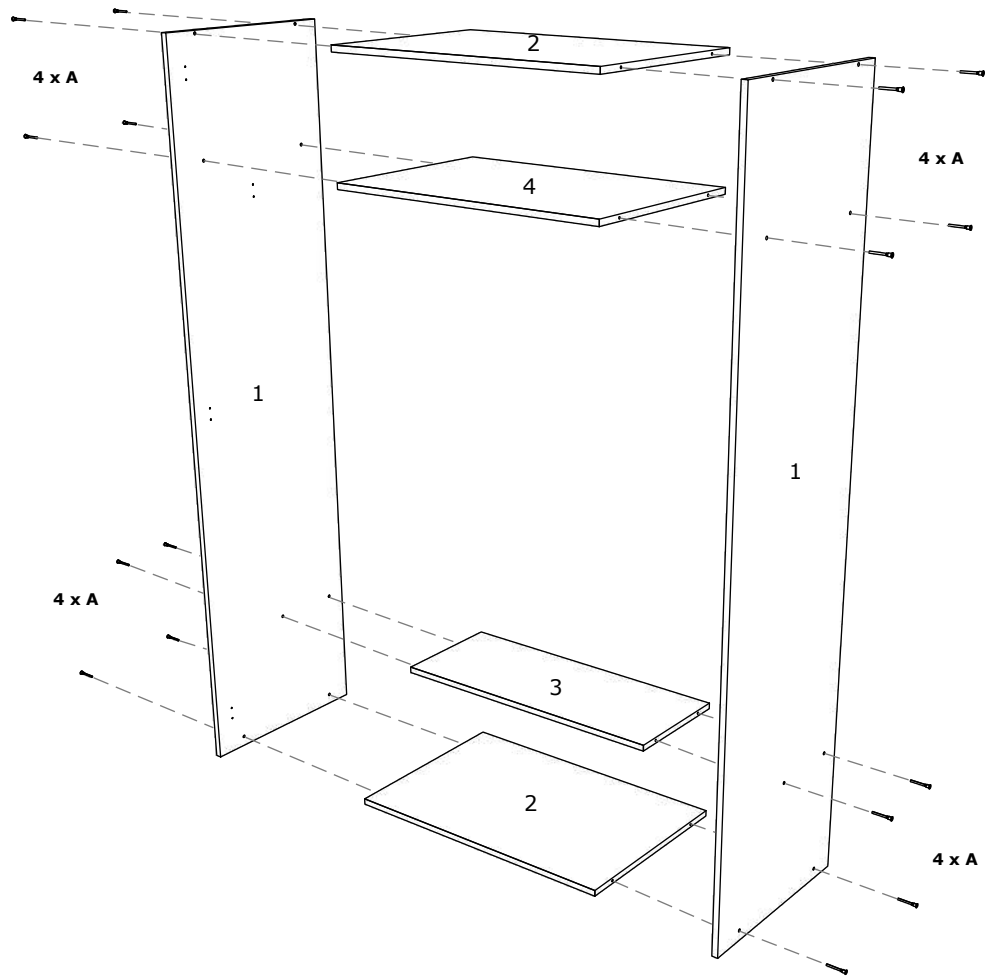

1

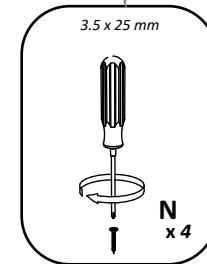
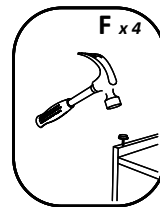
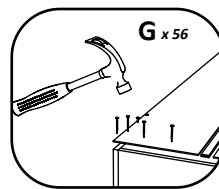
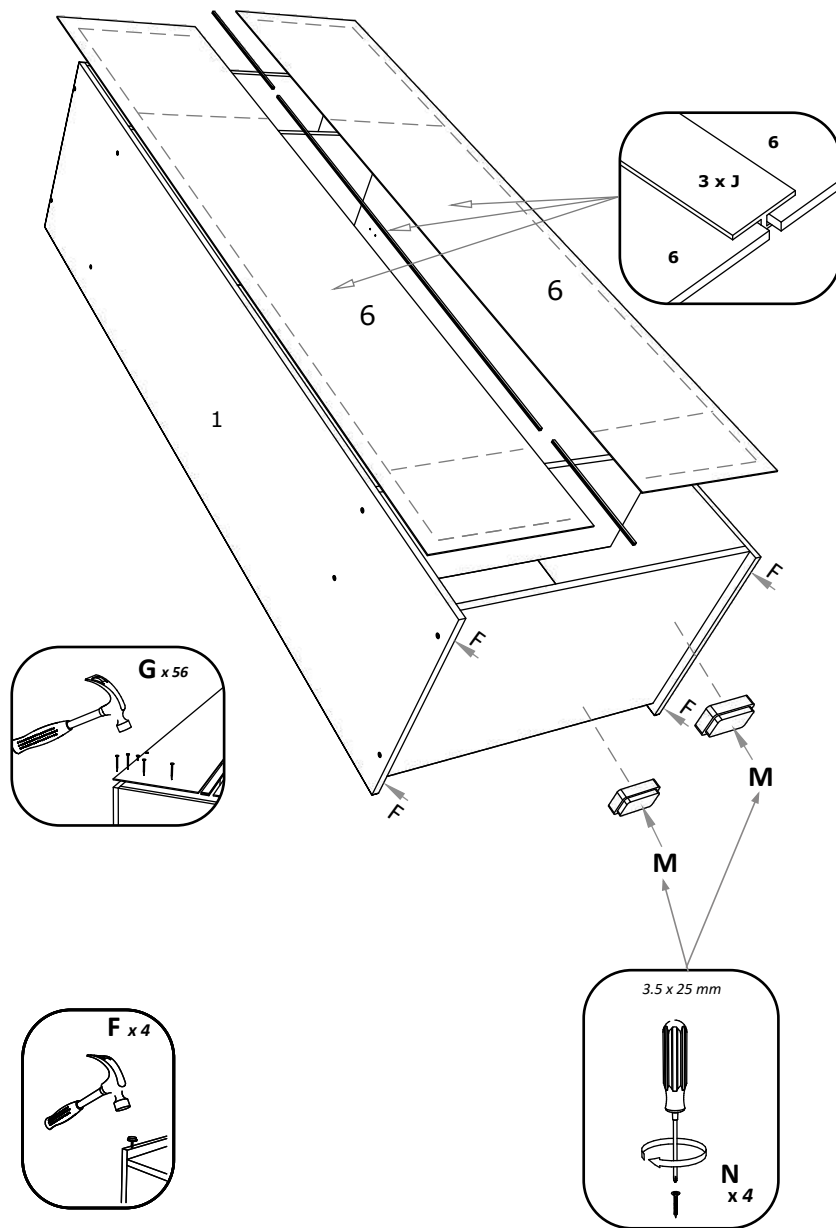

2

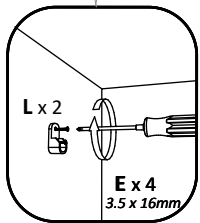
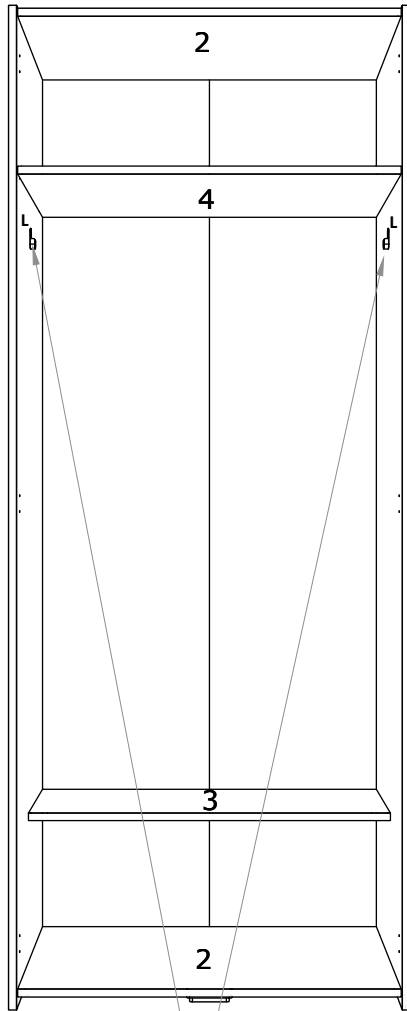

3

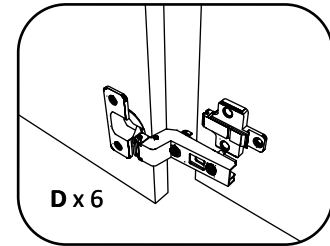
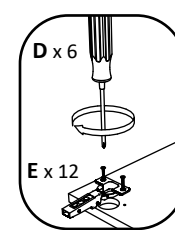
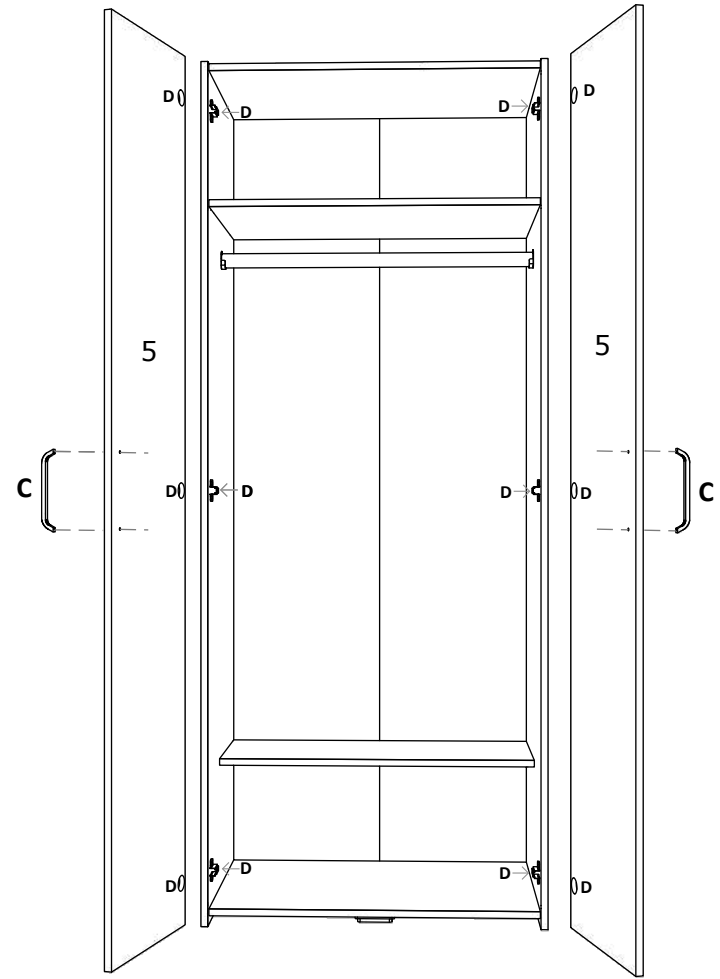
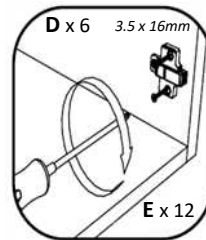
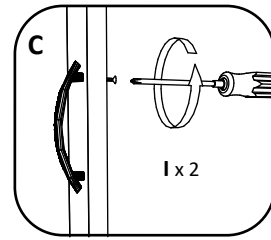

4

