

RO INSTRUCȚIUNI DE ASAMBLARE - **LIVING HAGA** - **SOLDAT 1 USA** - **1200 x 300 x 300 MM**

EN ASSEMBLY INSTRUCTIONS - **LIVING HAGA** - **1 DOOR HIGH CABINET** - **1200 x 300 x 300 MM**

FR ISTRUCTIONS DE MONTAGE - **VIVRE HAGA** - **ARMOIRE HAUTE 1 PORTE** - **1200 x 300 x 300 MM**

HU ÖSSZESZERELÉSI ÚTMUTATÓ - **ÉLŐ HAGA** - **1 AJTÓS MAGAS SZEKRENY** - **1200 x 300 x 300 MM**

BG ИНСТРУКЦИИ ЗА СГЛОБЯВАНЕ - **ЖИВА ХАГА** - **ВИСОК ШКАФ 1 ВРАТА** - **1200 x 300 x 300 MM**

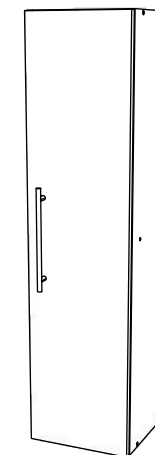

RO

NUMAR	LUNGIME	LATIME	BUC	CULOARE
1	1200	280	1	CULOARE
2	1200	280	1	CULOARE
3	268	280	2	CULOARE
4	268	268	2	CULOARE
5	1196	296	1	CULOARE
6	1196	296	1	PANOU SPATE
7	268	268	1	CULOARE

EN

NUMBER	LENGTH	WIDTH	PCS	COLOUR
1	1200	280	1	COLOUR
2	1200	280	1	COLOUR
3	268	280	2	COLOUR
4	268	268	2	COLOUR
5	1196	296	1	COLOUR
6	1196	296	1	BACK PANNEL
7	268	268	1	COLOUR

HU

SZÁM	HOSSZA	SZÉLES	DARAB	SZÍN
1	1200	280	1	SZÍN
2	1200	280	1	SZÍN
3	268	280	2	SZÍN
4	268	268	2	SZÍN
5	1196	296	1	SZÍN
6	1196	296	1	HÁTULSÓ PANEL
7	268	268	1	SZÍN

BG

Номер	Дължина	Ширина	Парчета	Цвят
1	1200	280	1	Цвят
2	1200	280	1	Цвят
3	268	280	2	Цвят
4	268	268	2	Цвят
5	1196	296	1	Цвят
6	1196	296	1	Заден панел
7	268	268	1	Цвят

FR

NOMBRE	LONGUEUR	LARGEUR	PIÈCES	COULEUR
1	1200	280	1	COULEUR
2	1200	280	1	COULEUR
3	268	280	2	COULEUR
4	268	268	2	COULEUR
5	1196	296	1	COULEUR
6	1196	296	1	PANNEAU ARRIÈRE
7	268	268	1	COULEUR

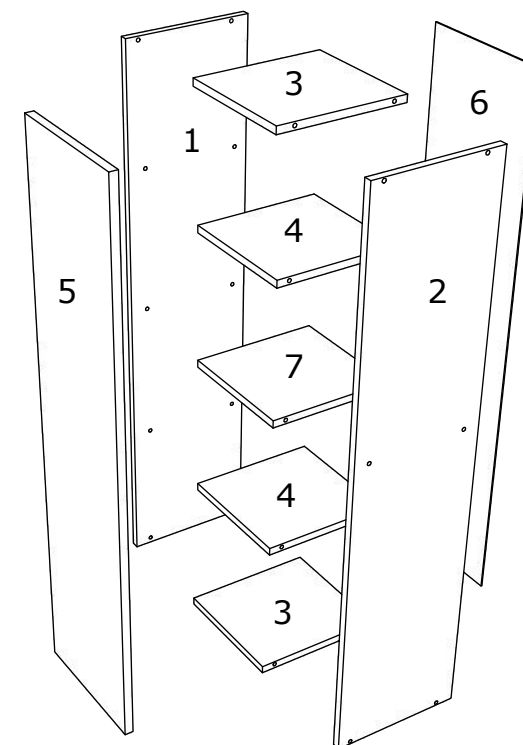

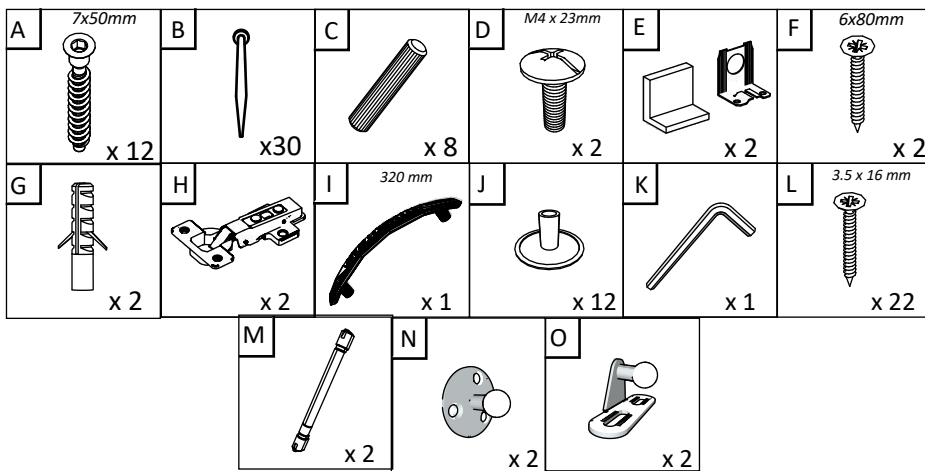
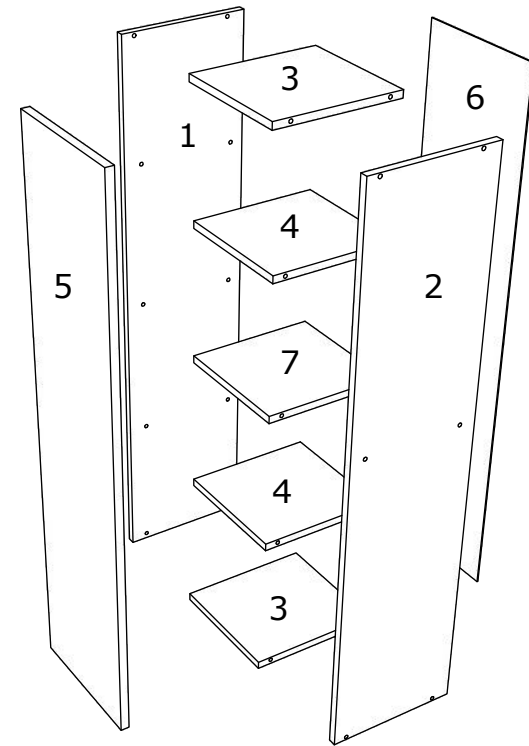
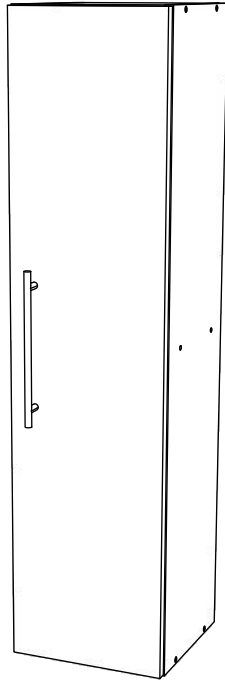

EN

NUMBER	LENGTH	WIDTH	PCS	COLOUR
1	1200	280	1	COLOUR
2	1200	280	1	COLOUR
3	268	280	2	COLOUR
4	268	268	2	COLOUR
5	1196	296	1	COLOUR
6	1196	296	1	BACK PANNEL
7	268	268	1	COLOUR

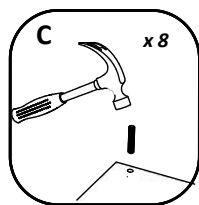
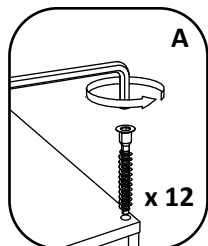
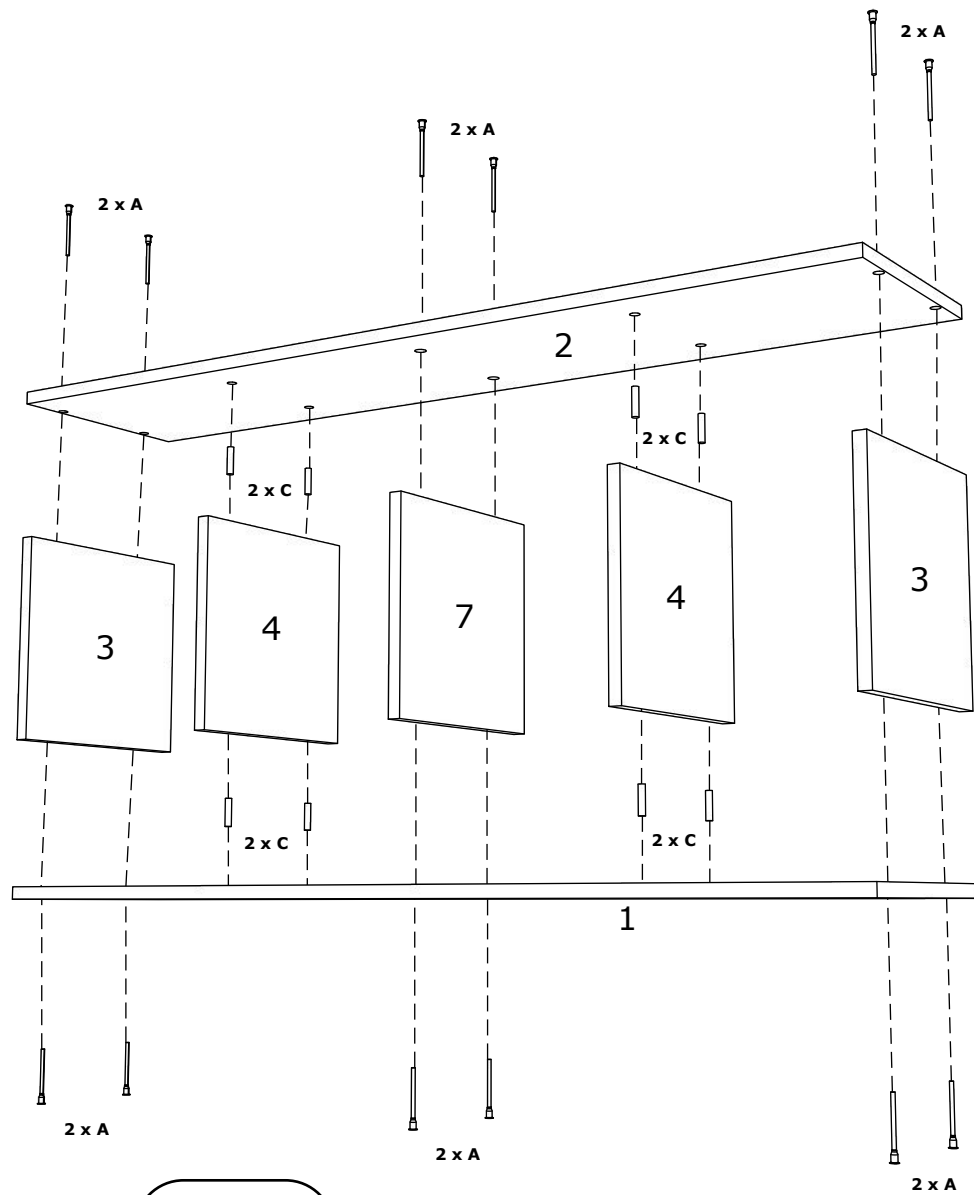

1

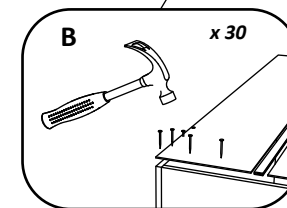
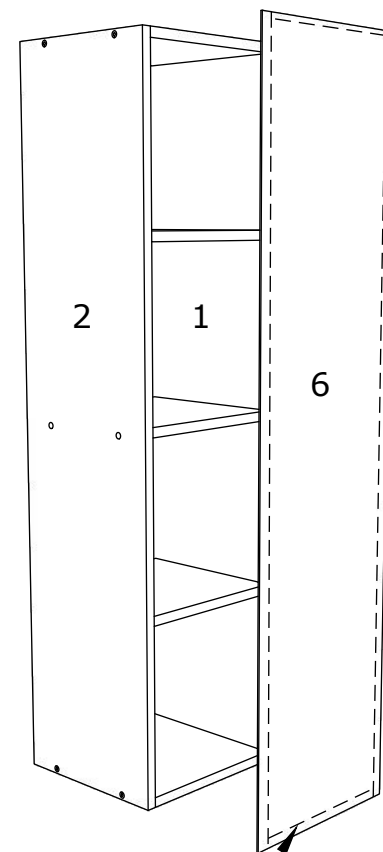

2

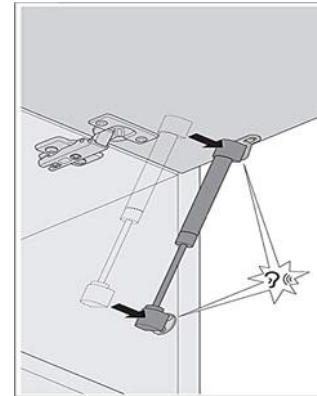
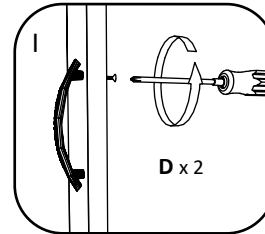
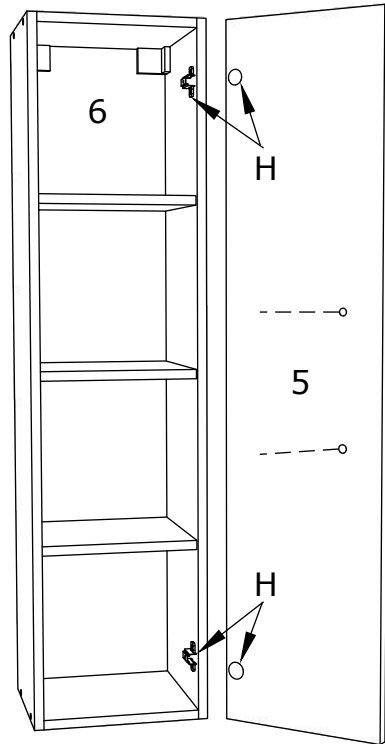
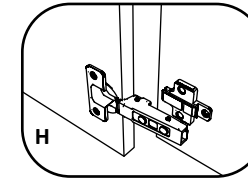
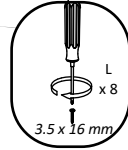
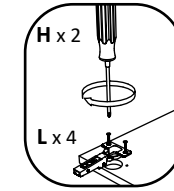
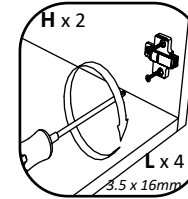
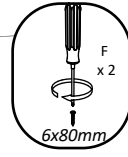
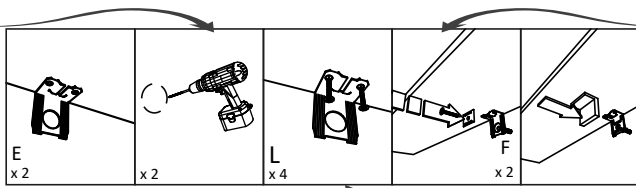

OR

